

Instruction Manual

CCP Intensity Probe Type 50GI



G.R.A.S.
SOUND & VIBRATION

Skovlytoften 33, 2840 Holte, Denmark
www.gras.dk gras@gras.dk

CCP Intensity Probe Type 50GI

Revision 6 June 2014

CONTENTS

1	Introduction	3
1.1	Description	3
1.2	Main Features	3
2	Delivered Components	4
2.1	Microphones	6
2.2	Preamplifiers	6
2.3	Spacers	7
3	Assembly	8
3.1	Assembling the Probe	8
3.2	Using the Windscreen	11
3.3	Changing the Spacer (to cover a different frequency range)	11
4	Calibration	12
4.1	Checking the Sensivity and P-I index using a Pistonphone	12
4.2	Checking the Probe's P-I Index using an Intensity Calibrator	13
5	Typical Application Setup	14
6	Specifications	15
7	Accessories	16

1 Introduction

1.1 Description

The CCP Intensity Probe Type 50GI (Fig. 1.1) is a two-microphone sound intensity probe. It has a pair of G.R.A.S. phase-matched $\frac{1}{2}$ " prepolarized microphones Type 40GI (Fig. 1.2), two G.R.A.S. phase-matched $\frac{1}{4}$ " microphone preamplifiers Type 26CB-Set, solid spacers, probe handle, and connection cable. The probe is adjustable, durable and fully complies with the following requirements:

- IEC 61043, Electroacoustics - Instruments for the Measurement of Sound Intensity - Measurements with Pairs of Pressure Sensing Microphones, 1993 for Class 1 sound intensity probes.



Fig. 1.1 The CCP Intensity Probe Type 50GI

1.2 Main Features

The CCP Intensity Probe Type 50GI is a simple-to-use and reliable probe designed with the following features:

- Complete Sound Intensity Probe for noise source location and sound power measurements
- Easy connection to analyzer equipment with IEPE (CCP) inputs
- Complete ready-to-use kit delivered in a carrying case
- Easy to calibrate.

2 Delivered Components

The main components of the CCP Intensity Probe Type 50GI are:

- ½" Intensity Microphone Set, prepolarized Type 40GK (see section 2.1)
- Preamplifiers Type 26CB-Set (see section 2.2)
- Four solid spacers of various lengths and a spacer cup (see section 2.3)
- Probe handle.

As shown in Fig. 2.1, the Type 50GI is delivered in a carrying case complete with microphones, preamplifiers, and standard accessories.



Fig. 2.1 The components delivered with the Type 50GI. See also Fig. 2.2.

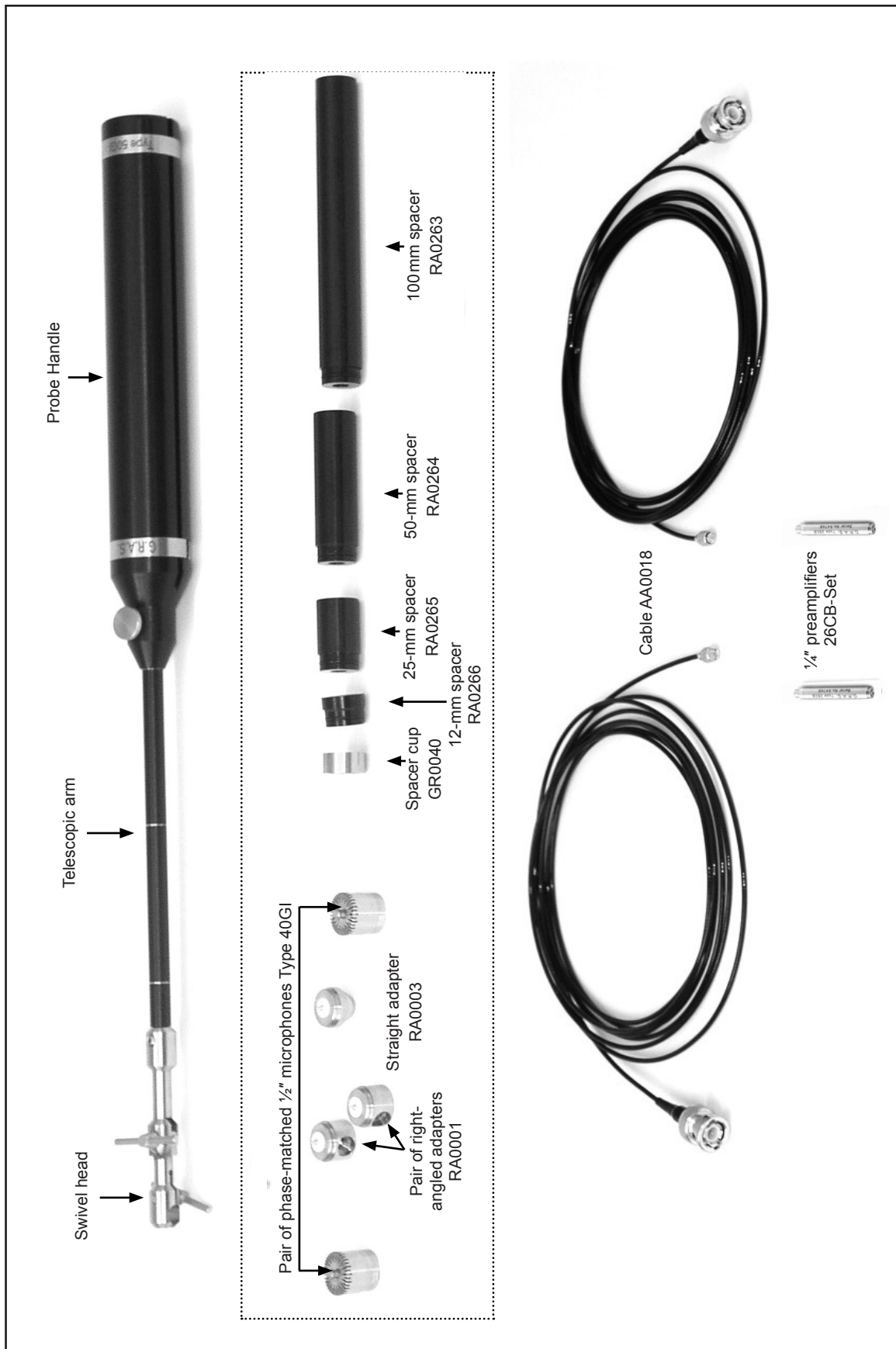

Fig. 2.2 Showing the complete range of delivered components apart from the wind screen

2.1 Microphones

The microphones (Fig. 2.3) are $\frac{1}{2}$ " prepolarized free-field condenser microphones with high sensitivity and a uniquely-designed pressure equalization system that ensures extremely well-defined phase characteristics. The microphones and preamplifiers are mounted onto the end of the telescopic arm of the Probe handle. To cover the full frequency range from 30 Hz to 10 kHz, the Type 50GI is delivered with four solid interchangeable spacers for spacing the microphones at 12 mm, 25 mm, 50 mm, and 100 mm.



*Fig. 2.3 Showing similar pairs of phase-matched $\frac{1}{2}$ " microphone cartridges:
Above: Type 40GK which includes spacers and three adapters for $\frac{1}{4}$ " preamplifiers as supplied with the Type 50AI-L
Below: Type 40GI (cartridges only)*

2.2 Preamplifiers

The small $\frac{1}{4}$ " diameter and 40 mm long CCP microphone preamplifiers (Fig. 2.4) are housed in robust, stainless steel casings which enable novel probe designs that reduce disturbances to the sound field otherwise brought about by the effects of shadows and diffraction. Symmetry of design enables reliable calibrations as described in the proposed standard (ISO/DIS 9614-2) for sound power measurements using sound intensity measurements.

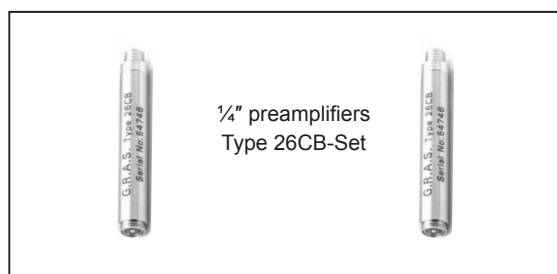

Fig. 2.4 $\frac{1}{4}$ " Preamplifiers Type 26CB-Set supplied with the Type 50GI

2.3 Spacers

To cover the wide frequency range (30 Hz - 10 kHz), Type 50GI is delivered with four solid spacers of various lengths and a spacer cup (Fig. 2.5).

To select the most appropriate spacer for the actual measurements, refer to Fig. 2.6.



Fig. 2.5 Showing the various spacers and the spacer cup supplied with the Type 50GI

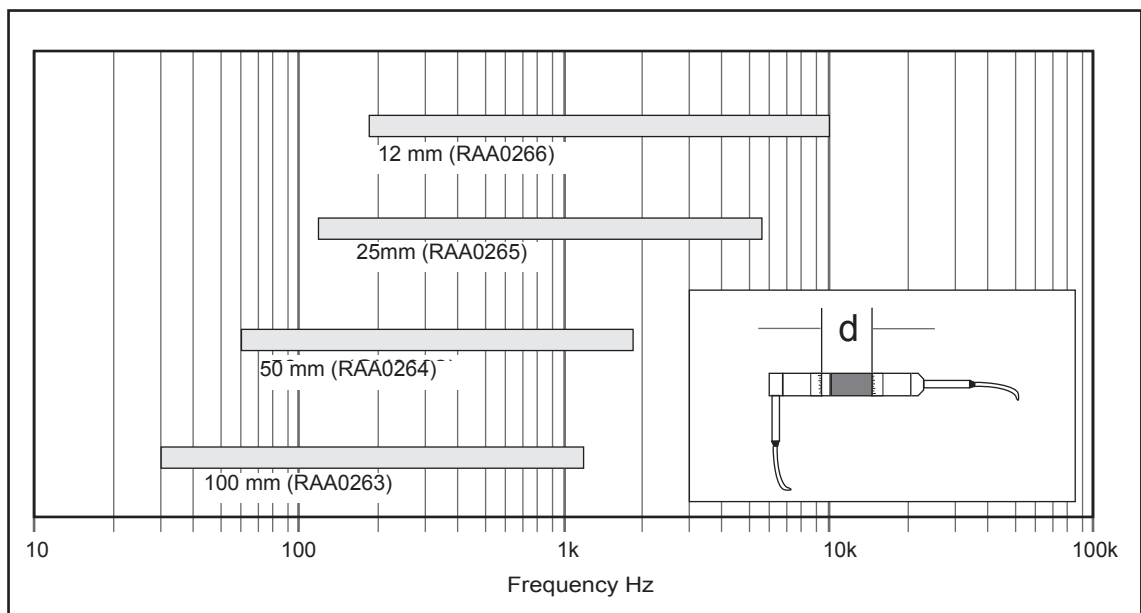

Fig. 2.6 Frequency ranges covered by the various spacer lengths.

3 Assembly

3.1 Assembling the Probe

The Intensity Probe can be assembled in either a straight setup or a symmetrical setup:

- The straight setup (Fig. 3.1), is for intensity measurements close to surfaces and general source location measurements.
- The symmetrical configuration (Fig. 3.2), is ideal for sound power measurements, for example according to international standard ISO 9614-2 “Acoustics - Determination of sound power levels of noise sources using sound intensity” where a rotation test is required.

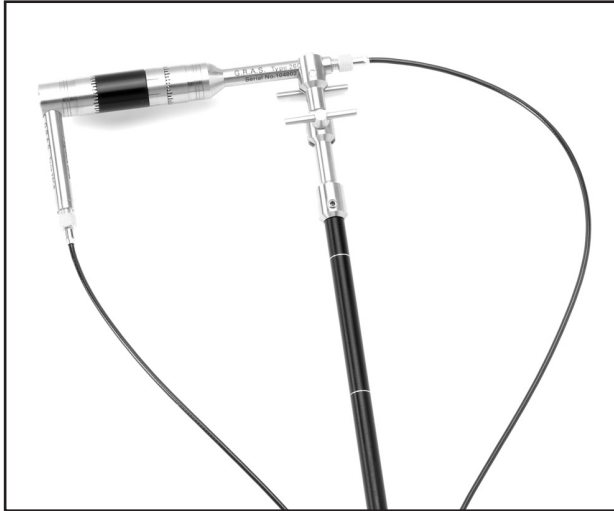

Fig. 3.1 Straight setup using the 25-mm spacer



Fig. 3.2 Symmetrical setup using the 12-mm spacer

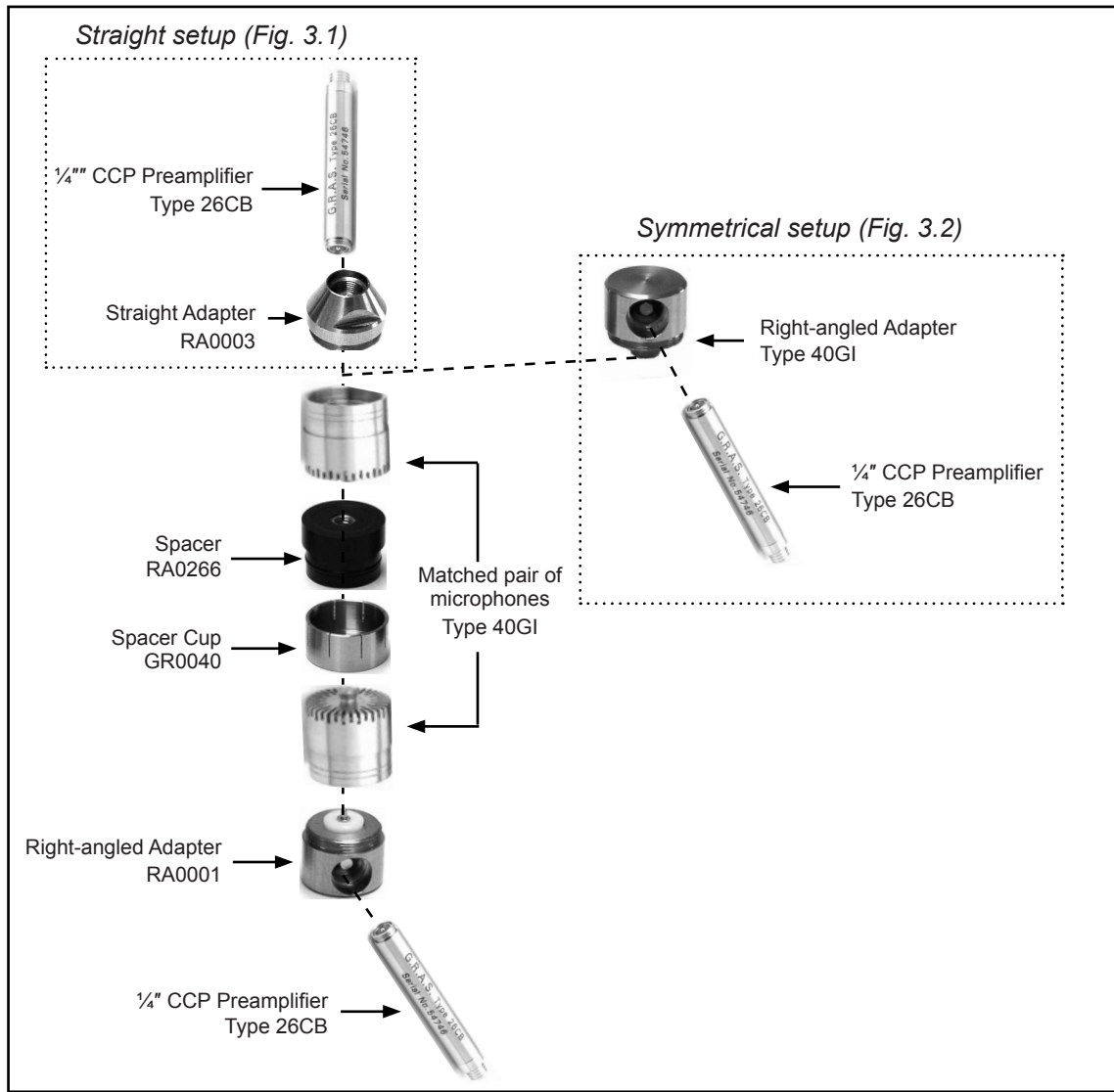

Fig. 3.3 Exploded view of probe assembly for both straight and symmetrical setup

Assemble as follows:

1. Mount either of the microphones onto a Right-angled Adapter RA0001 and the other microphone onto either the other Right-angled Adapter RA0001 (symmetrical configuration) or the Straight Adapter RA0003 (straight configuration).
2. Unscrew the black protection caps from the two CCP Pre-amplifiers Type 26CB.
3. Mount the microphone-adapter assemblies onto the preamplifiers.
4. Screw the Spacer Cup GR0040 onto the protection grid of one of the microphones.
5. Among the four spacers supplied, select the most appropriate one for the frequency range you wish to measure. Refer to Fig.2.6 to read off frequency ranges for the spacers. In many cases, the 25-mm spacer RA0265 will be appropriate and will cover the frequency range from 100 Hz to 6.3kHz*.
6. Screw the spacer onto the protection grid of the other microphone.

*According to the investigations of Jacobsen, Keith, and Krishnappa, diffraction effects at the intensity probe compensate for the insufficiencies of the finite difference approximation. The frequency range of intensity measurements may therefore be extended to frequencies up to 10kHz using 1/2" probes with a 12-mm spacer.

7. Now assemble the probe head by pressing the free end of the spacer (mounted on the one microphone) into the spacer cup mounted on the other microphone:

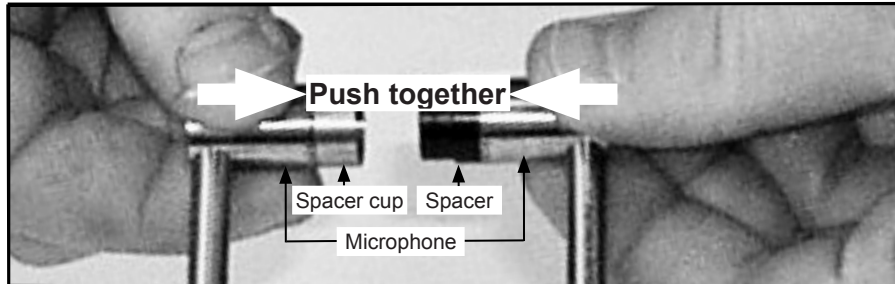

Fig. 3.4 Assembling the probe head (shown for the symmetrical setup)

8. Mount the probe head by sliding either of the preamplifiers into the clamp (which can be locked at angles of 0°, 45°, 90°, 135° and 180°) at the top of the telescopic arm, and tighten the finger screw (see the examples in Figs. 3.1 and 3.2).

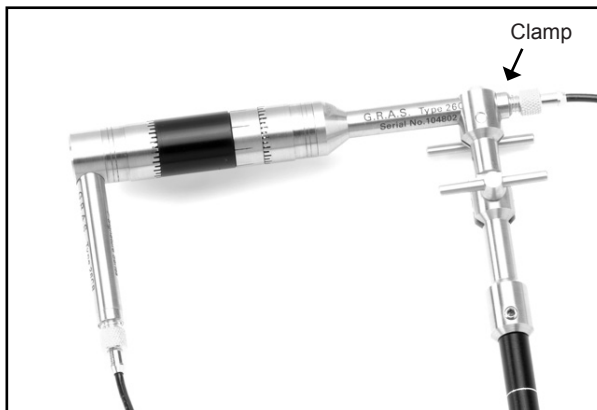

Fig. 3.5 Probe head mounted on the probe (straight setup)

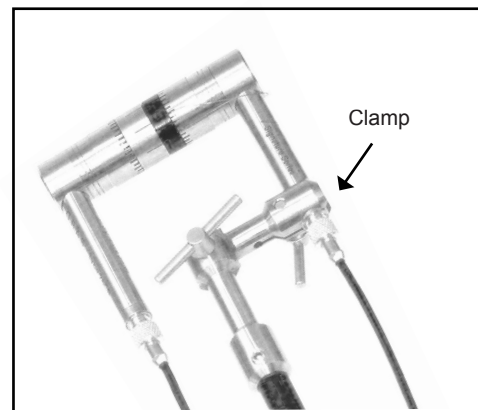

Fig. 3.6 Probe head mounted on the probe (symmetrical setup)

9. Connect the Cable AA0018 to the preamplifiers (Fig. 3.7).
10. Mount the cables into the cable guides of the probe handle (Fig. 3.7).

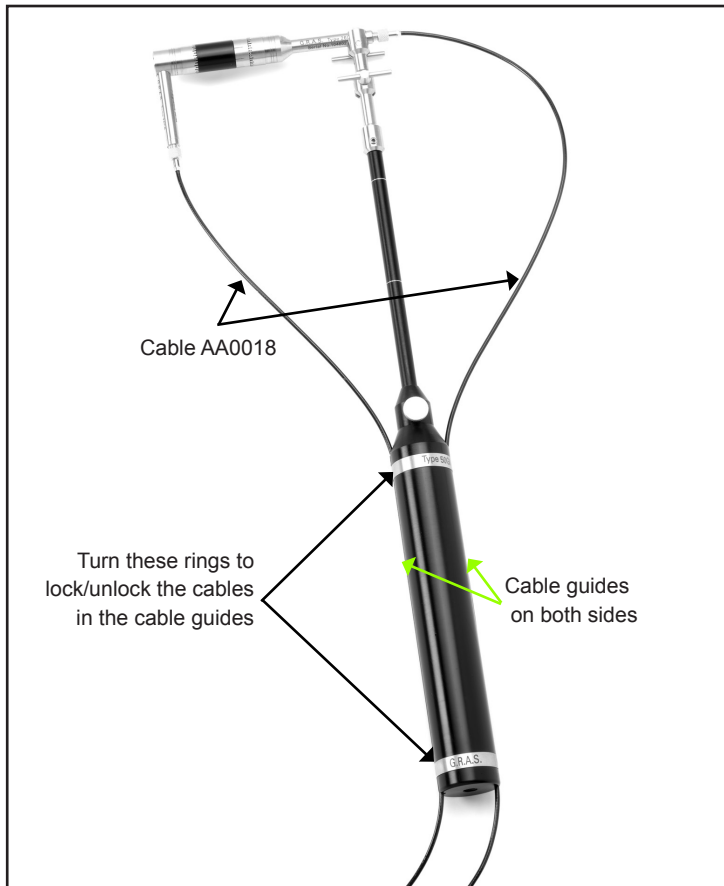

Fig. 3.7 Example of completely assembled Probe Type 50GI (symmetrical setup with 25-mm spacer)

3.2 Using the Windscreen

The Sound Intensity Probe Type 50GI includes an elliptical windscreen (AI0001) which can be used whenever making outdoor measurements or when making indoor measurements in the presence of bulk air movements. Use it only when measurements are influenced by wind. It gives good protection at wind speeds greater than 0.5 m/s and can reduce pressure fluctuations caused by turbulence by as much as 20 dB with this technique of intensity measurements.

3.3 Changing the Spacer (to cover a different frequency range)

1. Dismantle the probe head by pulling the spacer out of the spacer cup (Fig. 3.8)
2. Unscrew the spacer and replace it with the one covering the desired frequency range (see Section 2.3 Spacers).

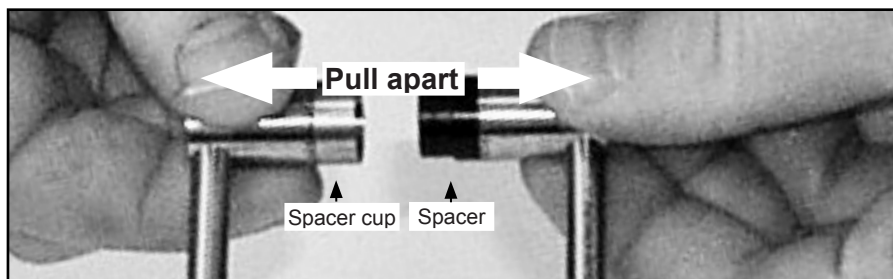

Fig. 3.8 Changing the spacer

4 Calibration

4.1 Checking the Sensitivity and P-I Index using a Pistonphone

4.1.1 Checking the Sensitivity

Check the sensitivity of the microphones using a Pistonphone Type 42AP (recommended) or Type 42AA. Refer to the manual supplied with the pistonphone for instructions on using the pistonphone.

4.1.2 Checking the P-I Index (Pressure Intensity)

Check the P-I index using Two-port Calibration Coupler RA0024 and a pistonphone, either Type 42AP (recommended) or Type 42AA. Refer to the manual supplied with the pistonphone for instructions on using the pistonphone.

1. Dismount the standard ½" coupler (Fig. 4.1).

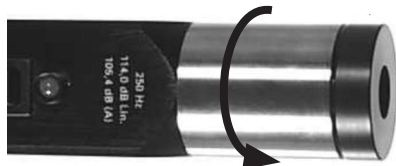

Fig. 4.1

2. Mount the Two-port Calibration Coupler RA0024, and insert the two microphones into its ports (Fig. 4.2). *The two microphones will be subjected to the same pressure level.*



Fig. 4.2

You will have to add the two-port correction factor for the RA0024 to the calibration value given for the pistonphone. The sound pressure level L_{2P} obtained in the two-port adapter is then:

$$L_{2P} = L_P + L_C$$

L_P : normal pistonphone level corrected for the barometric pressure
 L_C : two-port correction factor (nominal 8.0 dB)

If the pistonphone is used an ambient temperature different from that ambient static pressure (1013 hPa), the sound pressure level must be corrected accordingly.

Two-port correction factor (nominal):	8.0 dB
Nominal Frequency	250 Hz

4.2 Checking the Probe's P-I Index using an Intensity Calibrator

The P-I (Pressure Intensity) index of the sound intensity microphone pair and preamplifiers can be checked using the Intensity Calibrator Type 51AB - proceed as follows:

1. Mount the intensity microphones on their preamplifiers.
2. Connect the preamplifier outputs to the sound-intensity analyzer¹.
3. Insert the microphones into the holes at the ends of the Intensity Calibrator, making sure to push them all the way in.
4. Set the intensity analyzer to measure intensity corresponding to a 25 mm microphone spacing.
5. Apply a signal¹ to the BNC input of the Intensity Calibrator (signal must not exceed 1 V RMS).
6. Set the analyzer to mean pressure mode, and measure the result in decibels re. 20 μPa .
7. Set the analyzer to intensity mode and measure the result in decibels re. 10^{-12} W/m^2 .

The P-I index of the intensity probe is then the difference, in decibels, of these two results. For frequencies above 300 Hz, this should be at least 29 dB.

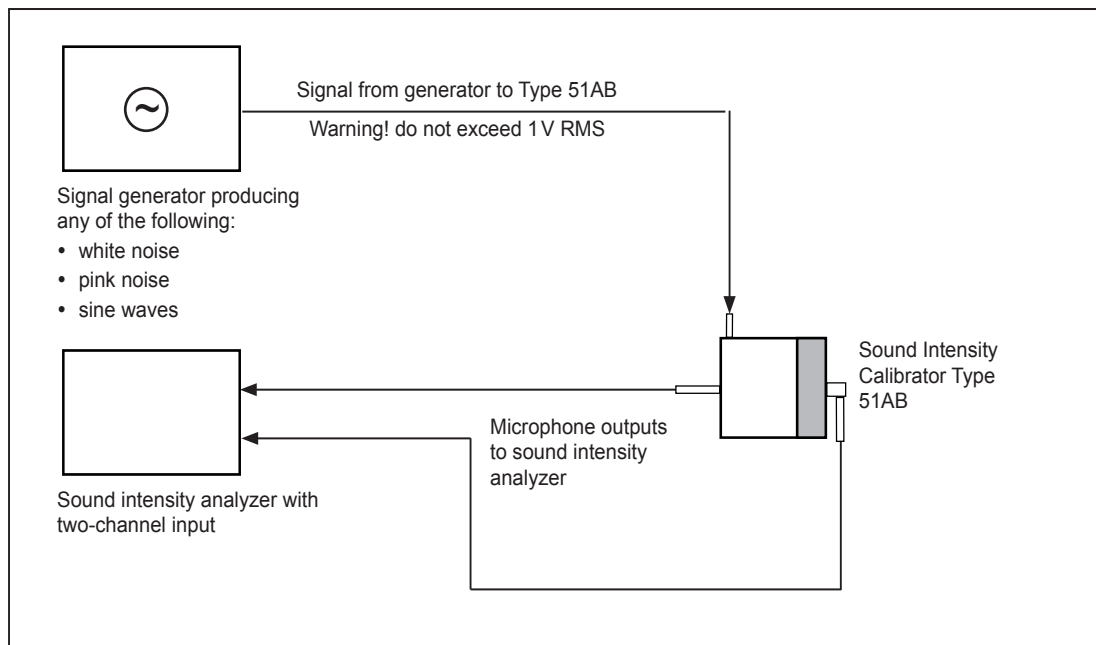

Fig. 4.1 Setup with signal generator and sound intensity analyzer

5 Typical Application Setup

Connect the probe to the Sound Intensity Analyzer via the appropriate adapter cable.

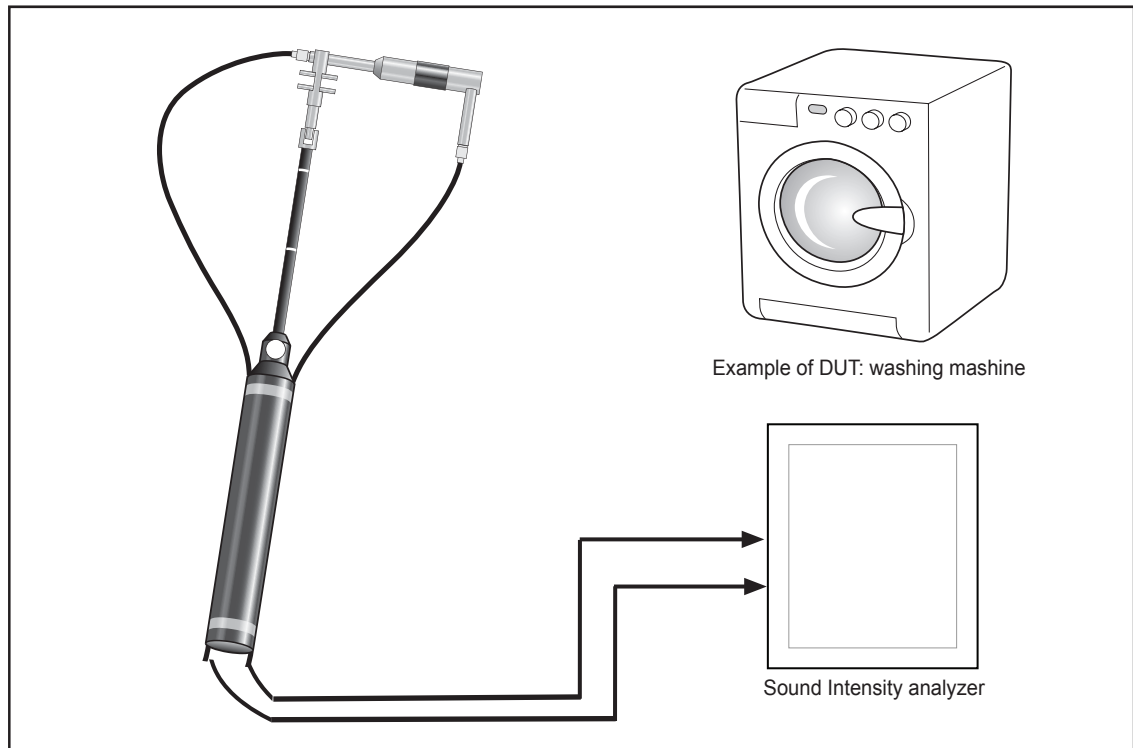

Fig. 5.1 Example of application setup: measuring the sound intensity of a washing mashine

6 Specifications

2 x Sound intensity microphone Type 40GK: ½" free-field

Frequency response and phase matching: IEC 61043 Class 1

1 x ¼" CCP Preamplifier Type 26CB-Set: Phase-matched

Weight: 0.3 kg (0.7 lbs)

Frequency range:

- with 100-mm spacer: 30 Hz - 1 KHz
- with 50-mm spacer: 80 Hz - 1.5 KHz
- with 25-mm spacer: 120 Hz - 5 KHz
- with 12-mm spacer: 200 Hz - 10 KHz

See also Product Data for Type 40GK and Type 26CB.

7 Accessories

7.1 Accessories included

Microphone set	Type 40GK
comprising:	
2 x ½" Free-field Sound	
Intensity Microphone	Type 40GI
Spacer, 100 mm	RA0263
Spacer, 50 mm	RA0264
Spacer, 25 mm	RA0265
Spacer, 12 mm	RA0266
Straight adapter	RA0003
Angled adapter	RA0001
1 x ¼" CCP Preamplifiers	Type 26CB-Set
3-m cable (supplied with Type 26CB)	AA0018
Probe handle	AI0044
Windscreen	AI0001

7.2 Optional Accessories

Power Module, single-channel CCP	Type 12AL
Power Module, dual-channel	Type 12AQ
8-mm Spacer for microphone separation:	GR0045
Microphone Adapter (microdot-microdot (female))	AE0046
5-m Cable (microdot-BNC)	AA0061
10-m Cable (microdot-BNC)	AA0062
For Calibration	
Intensity Calibrator	Type 51AB
Pistonphone with built-in barometer and thermometer (recommended)	Type 42AP
Pistonphone	Type 42AA
Two-port Calibration Coupler	Type RA0024

Manufactured to conform with:

CE marking directive:
93/68/EEC



WEEE directive:
2002/96/EC



RoHS directive:
2002/95/EC



G.R.A.S. Sound & Vibration continually strives to improve the quality of our products for our customers; therefore, the specifications and accessories are subject to change.